

KENT WET & DRY Vacuum Cleaner



Instruction Manual



August, 2017



Imported & Marketed by:

KENT RO SYSTEMS LTD.

4-B, Toy City, Ecotech III, Greater Noida (W). U.P.-201306

Ph.: +91-120-2397711

E-mail: sales@kent.co.in | Website: www.kent.co.in.

For customer complaints, contact our Customer Care Officer at:

E-6, 7 & 8, Sector-59, Noida, U.P. -201 309, India. Call: 092-789-12345

E-mail: service@kent.co.in or visit us at www.kent.co.in

New Age
Pure Cleaning
Healthy Living

Welcome to KENT



Dear Customer,

At the outset, allow us to thank you for your trust in KENT Wet & Dry Vacuum Cleaner. At KENT, we take pride in our reputation for product quality and industry proven performance. We are certain that your decision to own KENT Wet & Dry Vacuum Cleaner will go a long way towards keeping you and your family in good health. We are confident that you will be more than satisfied with its performance and it will serve your need for a safer and cleaner living, without any compromise.

This guide would help you in getting the best out of your KENT Wet & Dry Vacuum Cleaner. Please go through the booklet to familiarize yourself with its proper operation and maintenance. So that you can look forward to years of trouble-free service. To ensure that the warranty of your KENT Wet & Dry Vacuum Cleaner is effective, it is important that you fill up the enclosed warranty card and mail it to us within 15 days of purchase.

In case you require any further information, please contact your nearest KENT dealer/branch.

Happy Cleaning,

KENT RO Systems Ltd.

Table of Contents

1.	Introduction	1
2.	Features of KENT Wet & Dry Vacuum Cleaner	1
3.	Know Your Product	1
4.	Items in the Box	2
5.	Assembling your KENT Wet & Dry Vacuum Cleaner	2
6.	Using the Appliance	3
7.	Important Instructions	4
8.	Cleaning and Maintenance	5
9.	Important Safety Instructions	6
10.	Troubleshooting	7
11.	Technical Specifications	7

Introduction

We, at KENT have always believed that a clean and healthy life is the right of every individual. This ethos made us embark on the journey to develop innovative solutions for purifying water, fruits & vegetables and air. With the use of an innovative technology and supported by a competent service network, we have been able to create a brand, which has become synonymous with well-being and health.

Continuing with the tradition, we now present the KENT Wet & Dry Vacuum Cleaner, with state-of-the-art technology & feature to pick wet spills and dry dirt to provide clean, dust-free and spotless surroundings.

KENT Wet & Dry Vacuum Cleaners, do not use filtration bags, unlike traditional vacuum cleaners available in the market. The dust and wet spills is collected in a stainless steel body with a 10 L capacity for easy disposal of waste.

Features of KENT Wet & Dry Vacuum Cleaner

1. Picks up dry dust and wet spills from the surface.
2. Blower function to remove deep embedded dust.
3. Stainless steel body with 10 L capacity.
4. High efficiency motor with a strong suction force for efficient cleaning.
5. Rubberised wheel for ease movement.
6. Light weight & Low noise.

Know Your Product

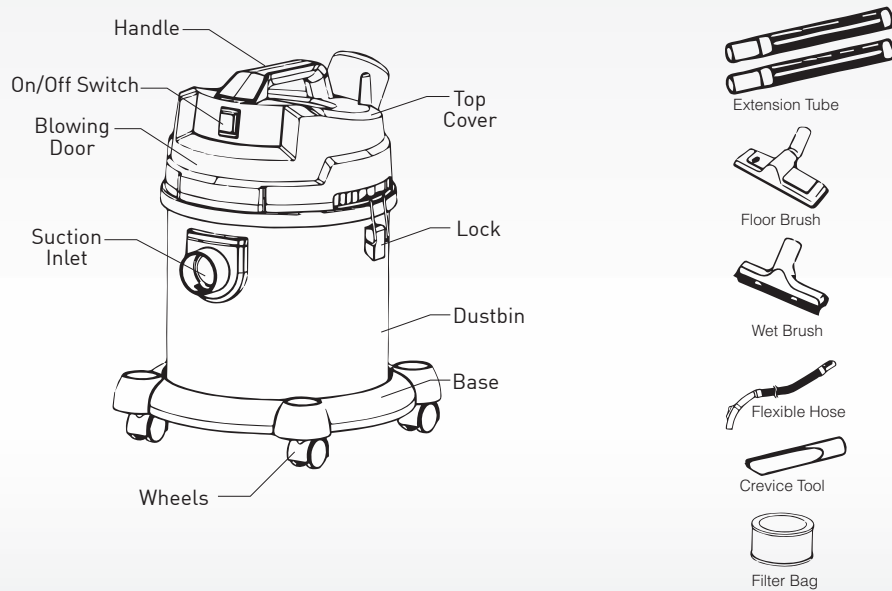

Items in the Box

1. KENT Wet & Dry Vacuum Cleaner	:	01 No.
2. Flexible Hose	:	01 No.
3. Extension Tube	:	01 No.
4. Crevice Tool	:	01 No.
5. Floor Brush	:	01 No.
6. Wet Brush	:	01 No.
7. Filter Bag	:	01 No.
8. User Guide	:	01 No.

Assembling Your KENT Wet & Dry Vacuum Cleaner

1. Unpack the unit completely and remove any stickers that can prevent unit operation.
2. Check the unit for damages. Do not use it in case of any damages.
3. Before switching on the unit, make sure that your home mains voltage corresponds to the unit operating voltage.

Attaching/ Detaching the Flexible Hose

a. Attaching

1. Attach the flexible hose in the air intake duct on the appliance, press until it clicks into position.
2. The grooves on the flexible hose cap must be aligned properly.

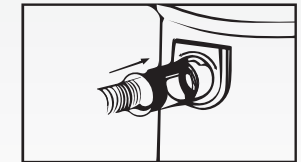

Attaching

b. Detaching

1. To detach the flexible hose from the air intake duct, rotate counter-clockwise and pull out.

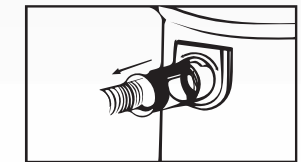

Detaching

Attaching/ Detaching Extension Tube

Attaching

- Attach the extension tube to the handle by pushing it in the direction as shown in the figure.

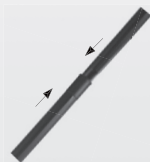

Detaching

- To detach it, pull in the reverse direction of the arrow.

Attaching/ Detaching Wet Brush & Floor Brush

Attaching

- Attach the wet brush to the extension tube in the direction of the arrow.

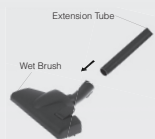

Detaching

- You can detach the extension tube from the wet brush by pulling it.

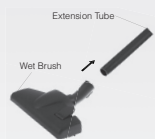

Using the Appliance

- Connect all the accessories.
- To use the appliance, plug the appliance to main power supply.
- Press on/off button to switch on your appliance.



Use of Accessories

Crevice Tool

- Your KENT Wet & Dry Vacuum Cleaner comes with a crevice tools which are ideal for cleaning surfaces, which are otherwise difficult to clean, such as radiators, couch corners, under the couch and in between cushions.



Crevice tool

Floor Brush

- Ideal for the daily cleaning of carpets and hard/ wooden floors.

Wet Brush

- An ideal tool when it comes to wet cleaning. Use flat nozzle crevice tool or water brush for cleaning.

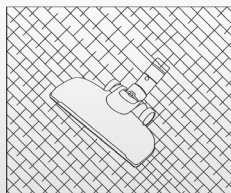

Carpet

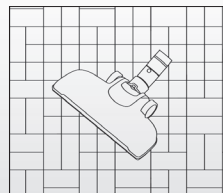

Hard/ Wooden Floor



Wet Brush

Important Instructions

1. Do not operate the vacuum cleaner too close to heaters, radiators, cigarette butts, etc.
2. Do not plug or unplug the device with wet hands.
3. Before using the vacuum cleaner, remove large or sharp objects from the floor in order to prevent damage of the HEPA filter.
4. To unplug, do not pull the electrical cord, instead pull out the plug.



Note: If the suction pipe or extension tube is blocked, switch-off the vacuum cleaner at once. Unplug the appliance and clear the blockage. Once done, start the vacuum cleaner again.

Cleaning and Maintenance

1. Switch-off and unplug the appliance before cleaning it.

Note: Never use gasoline, solvent, abrasive cleaning agents, metal objects or hard brushes to clean the appliance.

2. Cleaning Filters: Your KENT Wet & Dry Vacuum Cleaner comes with a washable foam and HEPA filters for effective dry and wet cleaning.

Removing and cleaning washable foam and HEPA filter

1. Remove the upper body assemble by opening the lock attached to the main body.

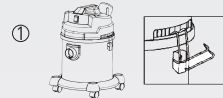

2. Gently pull the upper body to detach it from the main body.



3. Gently remove the filter cartridge by rotating and pulling it out.

4. Detach the HEPA filter from the outer foam filter by pulling it out.

5. Rinse filters in lukewarm water and dry them completely.

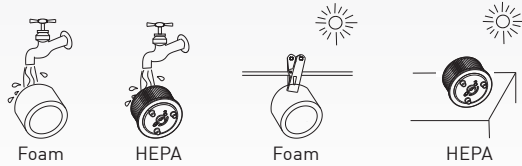

6. Once the filters are dry, put them back in reverse order.

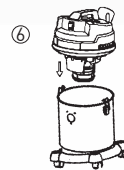

7. Filters should be cleaned at least twice in a year, or when it becomes visibly soiled.
8. Always operate the appliance with filters installed.
9. Always unplug the appliance before cleaning the filters.
10. Do not use washing machine to rinse filters.
11. Do not use a hair dryer to dry it.

Storage

- If you do not intend to use the appliance for a long time, store it carefully.
- Plug out the appliance when not in use.
- Keep the appliance out of the reach of children.



Warranty Card

(For sale through dealer)

Product: KENT Wet & Dry Vacuum Cleaner (KSL-612)

Serial No.:.....

CUSTOMER DETAILS:

Customer's Name:

Customer's Address:

Customer Phone No.:

WARRANTY DETAILS:

Invoice Date: Invoice No.:

FOR SERVICE CONTACT:

Service Provider's Name:

Service Provider's Address:

Ph. No.:

Imported and Marketed by:

KENT RO SYSTEMS LTD.

4-B, Toy City, Ecotech III, Greater Noida (W). U.P.-201306.

Ph.: +91-120-2397711

E-mail: service@kent.co.in | Website: www.kent.co.in

Customer Care: 092-789-12345

Terms & Conditions of Warranty

KENT warrants all new products manufactured by it to be free from defects in material and workmanship under normal usage and service from the date of purchase as under:

1. The Warranty period commences from the date of purchase by the first end-user. During this Warranty period of one year, KENT or its Authorized Service Provider (ASP) will replace or repair any part of KENT Vacuum Cleaner, that in the opinion of KENT or its ASP, would be defective in operation due to faulty material or workmanship (i.e. manufacturing defects) with the exception of consumables such as Filters.
2. The product's plastic body is not covered under Warranty and hence, it must be handled with care to guard against breakage.
3. The original purchaser of the unit can avail services under Warranty at the point of sale, by producing the damaged part(s) along with the original invoice.
4. This Warranty is void if the unit is not operated under normal conditions or according to the instructions given in the manual.
5. Product returned to KENT or its ASP for Warranty examination must be shipped freight prepaid.
6. KENT or its ASP shall not be held liable for claims exceeding the cost of repair of the defects in workmanship.
7. This Warranty Agreement shall not be interpreted to render KENT or its ASP liable for injuries or damages of any kind - direct, consequential or contingent to persons or property.
8. KENT or its ASP shall not be held responsible by representative or buyer for failure to abide by any of the obligations of this Warranty Agreement if such failures are the result of circumstances of Forces Majeures: such as, but not limited to, floods, earthquakes, transportation strikes, labour disputes with outside suppliers or any other conditions beyond the control of KENT or its ASP.
9. KENT or its ASP shall not be held liable for repair or alterations made without prior written approval; for products failures resulting from the lack of proper maintenance.
10. This Warranty Agreement excludes all products/component parts or damage to any part of this Vacuum Cleaner which, in the opinion of KENT or its ASP, have been subjected to misuse; misapplication; negligence; alteration; accident or operation contrary to our instructions, incompatibility with accessories not installed by KENT or its ASP, or that have been repaired with component parts other than those manufactured by or obtained from KENT or its ASP. Damage caused by freezing, flood, fire or Act of God is not covered by this Warranty. In all such cases regular charges will apply. This limited Warranty does not include service to diagnose a claimed malfunction in this unit.
12. KENT reserves the right to alter or improve design and specifications at any time, without any contingent obligations to prospective buyers or owners of the products previously sold.
13. Any disagreements and obligations based upon the purchase of KENT products and thereby imposed on KENT or its ASP shall be governed by and construed according to the laws of INDIA and subject to the jurisdiction of Delhi Courts only.
14. KENT or its ASP assumes no Warranty liability in connection with this Vacuum Cleaner other than that specified herein. This Warranty is in lieu of all other warranties, expressed or implied, including warranties of fitness for a particular purpose. KENT or its ASP does not authorize any person or representative to assume for them any other obligations on the sale of this Vacuum Cleaner.
15. Under no circumstances, the liability of KENT or its ASP shall exceed the value of the product.
16. Under no circumstances are the terms mentioned above negotiable and no employee of KENT or its ASP has the authority to supersede them.

Important Safety Instructions

When using an electrical appliance, basic precaution should always be followed, including the following:

1. Do not leave vacuum cleaner switched on when plugged in. Unplug, when not in use and before servicing.
2. Use the appliance only as described in the manual.
3. Always use manufacturer's recommended attachments only.
4. Do not use the appliance if the cord or plug is damaged or worn out. Replace the damaged cord or plug immediately.
5. Do not try to service the appliance on your own. Send it to an authorized service center.
6. Never use the cord as a handle, close door on cord, or pull cord around sharp edges or corners. Keep the cord away from heated surfaces.
7. Do not unplug the appliance by pulling the cord. Always unplug by pulling the plug out the cord.
8. To avoid electric shocks, do not use the appliance with wet hands.
9. Keep hair, loose clothing, fingers and all parts of body away from moving parts.
10. Turn off all controls before unplugging.
11. Use extra precaution while cleaning stairs.
12. Do not use the appliance to pick any flammable or combustible liquids, such as gasoline, and also do not use in the areas where they may be present.
13. Unplug before connecting the hose.
14. Do not pick up anything that is burning or leaving smoke, such as cigarettes, matches, or hot ash.
15. Never use the appliance without the filter in place.
16. If the supply cord is damaged, it must be replaced by the manufacturer or a service agent, or a similarly qualified person, in order to avoid a hazard.
17. This appliance is suitable for indoor use only.
18. Keep away from the reach of children.
19. The appliance is not designed to be used by people who are physically or mentally disabled, mentally handicapped or lack the relevant experience and knowledge, unless a person responsible for their safety uses the product with supervision and guidance.

Troubleshooting

Problem	Possible Cause	Possible Solutions
The appliance does not switch on.	<ol style="list-style-type: none"> 1. Power Cord not firmly plugged into socket 2. No power in the main supply 	<ol style="list-style-type: none"> 1. Plug in the unit firmly. 2. Check the fuse or cutout switch. Replace fuse or reset the switch. 3. Call authorized service center.
The appliance has weak suction power	Filters are blocked	<ol style="list-style-type: none"> 1. Switch-off the cleaner and disconnect the cleaner from main power supply. 2. Remove the filter and clean them. 3. Clean the remaining dust inside the dust container.
The hose or brush does not pick any dust	Hose is choked or some blockage on brush	<ol style="list-style-type: none"> 1. Switch-off the cleaner and disconnect the cleaner from main power supply. 2. Remove hose and/or brush and remove any blockage.

Technical Specifications

Model Name	KENT Wet & Dry Vacuum Cleaner
Model Number	KSL-612
Net Weight	6.2 kg
Input Power Supply	Single Phase 220 V AC, 50 Hz. 
Max. Vacuum Pressure	> 22 kpa
Airflow	> 1.6 m ³ /min
Noise (dB)	< 86 dB (A)
Power Cord Length	10 m
Maximum Power	1400 W